

BB0004119

足カバー F

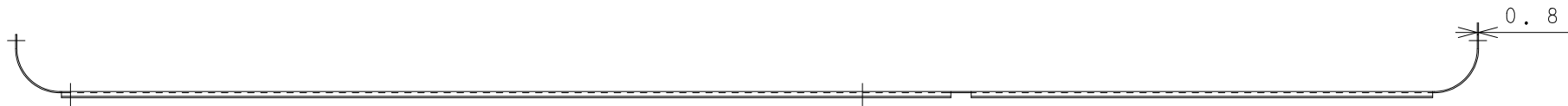

同梱のタッピングネジで足カバー L に固定する

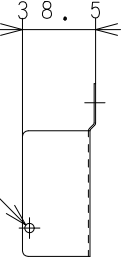

本体左前面カバー取付ネジで固定 (2ヶ所)

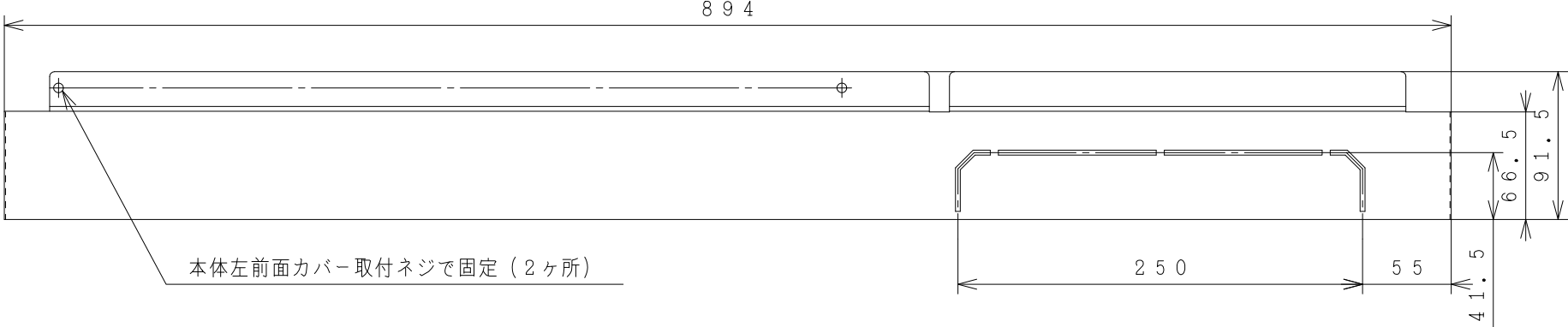

同梱のタッピングネジで足カバー R に固定する

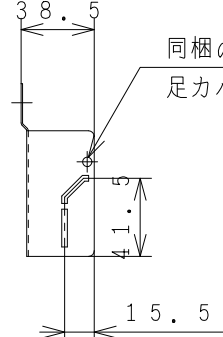

足カバー L



足カバー R



416

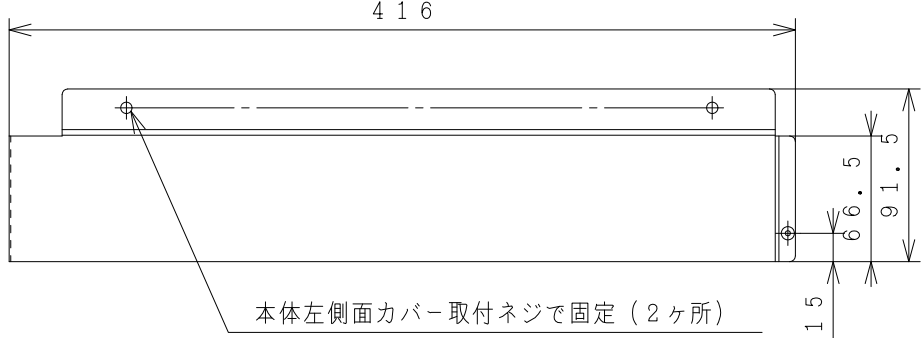

本体左側面カバー取付ネジで固定 (2ヶ所)

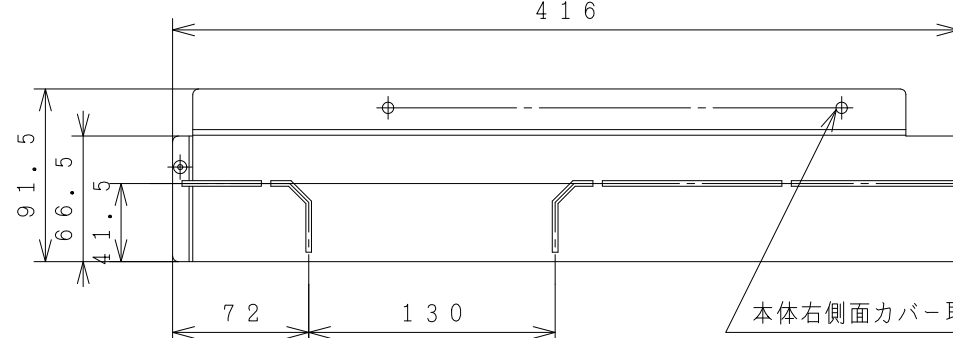
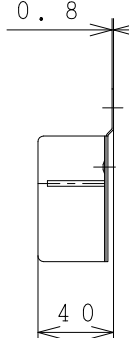
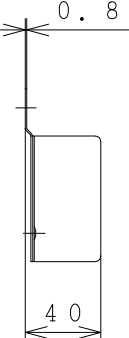

本体右側面カバー取付ネジで固定 (2ヶ所)

本体取付図 (NTS)

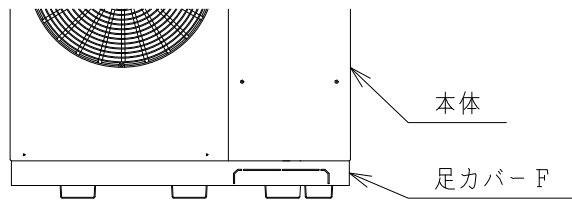
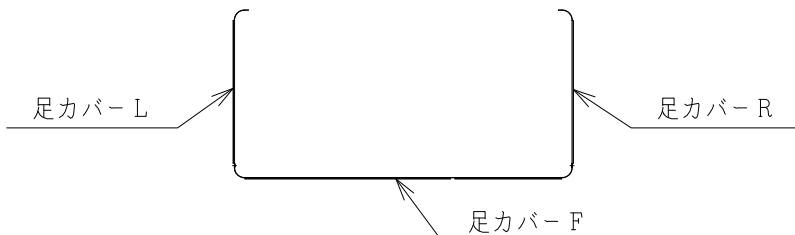

SIGNATURE		DATE	PROJECTION	SCALE	TITLE
DWN.	K. Sakamoto	2006-05-31		NTS	RHKAK-1 構造:寸法図
CHKD.	M. Murayama	2006-05-31			
APPD.	M. Murayama	2006-05-31			
			Hitachi Global Life Solutions Inc. Tokyo Japan		TOCHIGI DWG. No. 3YAA BB0004119
					 REGD. REGD 2006 0601